

Installation Guide BT Coupler System

Ancon BT Couplers are designed to join two reinforcing bars of the same size. They can be assembled in the same concrete pour using Types A, B & C connections or in separate concrete pours using Types A & C connections with the assistance of Nailing Plates and small polystyrene block-outs.

The following table shows the correlation between bar sizes and the BT Couplers, Locknuts, Nailing Plates & Thread dimensions.

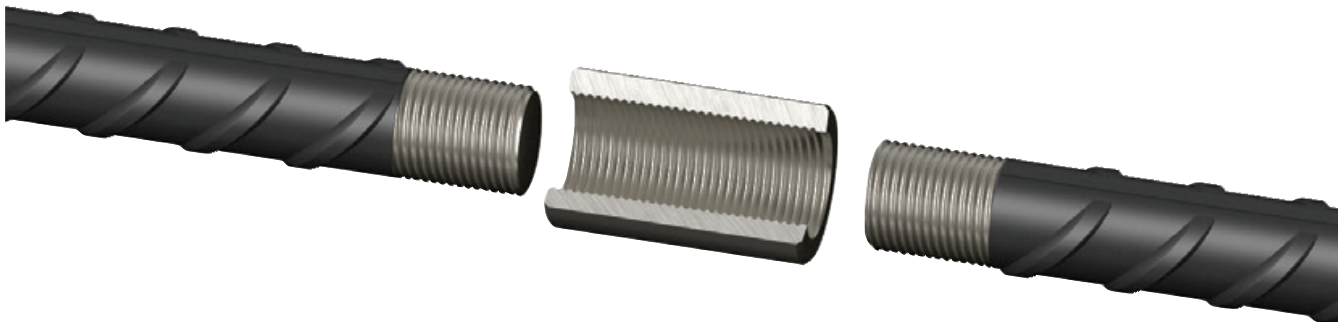
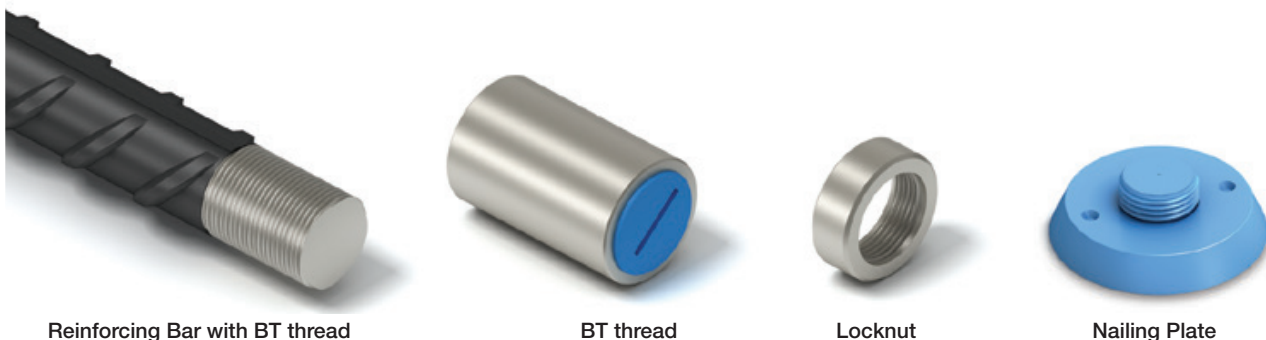

Table 1 - Correlation between bar size, BT Couplers, Locknuts, Nailing Plates & Thread dimensions

Bar Size	BT Coupler	Locknut	Nailing Plate	Thread Size x Thread Pitch	Thread Length			
					Type A	Type B	Type C1	Type C2
N12	BTC12	BTLN12	NP14 (orange)	M14 x 2.0	14	28	26	40
N16	BTC16	BTLN16	NP20 (blue)	M20 x 2.5	20	40	32	52
N20	BTC20	BTLN20	NP24 (yellow)	M24 x 3.0	24	48	36	60
N24	BTC24	BTLN24	NP30 (grey)	M30 x 3.5	30	60	45	75
N28	BTC28	BTLN28	N/A	M33 x 3.5	33	66	48	81
N32	BTC32	BTLN32	N/A	M36 x 4.0	36	72	57	87
N36	BTC36	BTLN36	N/A	M42 x 4.5	42	84	70	104
N40	BTC40	BTLN40	N/A	M45 x 4.5	45	90	73	110

Thread Lengths are based on round locknuts.



Reinforcing Bar with BT thread

BT thread

Locknut

Nailing Plate

1A Installation of BT Type A connection

The Type A connection contains one BT Coupler and two reinforcing bars with Type A threads.

The bar is typically supplied with the Coupler already installed. In this case, begin with step 1A-2.

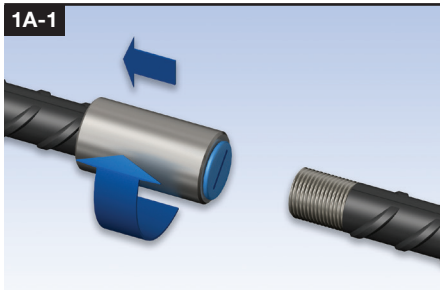

Screw the coupler to the rear of the thread on the fixed bar and lock tight. The bar end should be central within the coupler.

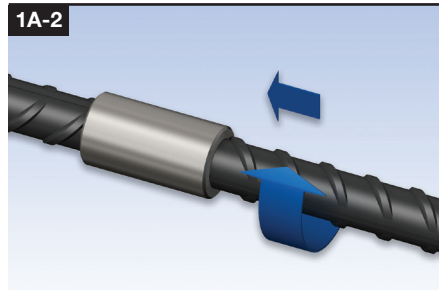

Remove the plastic cap from the coupler. Position and rotate the continuation bar in the coupler.

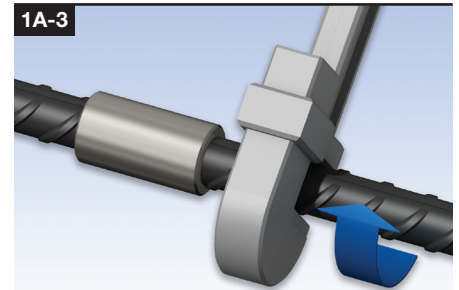

Tighten the joint using a wrench on the continuation bar. After tightening there should be no more than 2-4mm of thread exposed, depending on the diameter of the rebar.

1B Installation of BT Type B connection

The Type B connection contains one BT Coupler, one reinforcing bar with a Type A thread, and one reinforcing bar with a Type B thread.

The bar is typically supplied with the Coupler already installed. In this case, begin with step 1B-2.

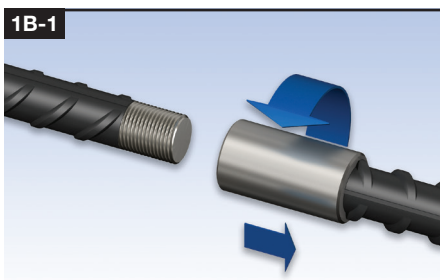

Screw the coupler to the rear of the thread on the continuation bar.

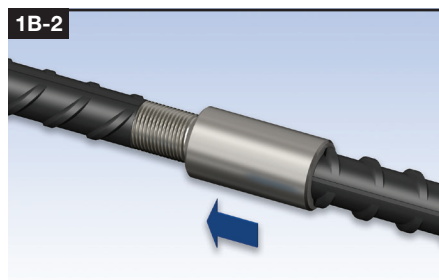

Position the continuation bar with the coupler against the end of the first bar.

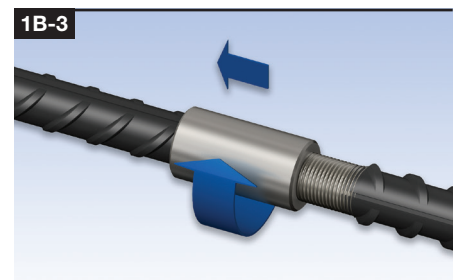

Rotate the coupler from the continuation bar to engage against the rear of the thread on the opposing bar and lock tight.

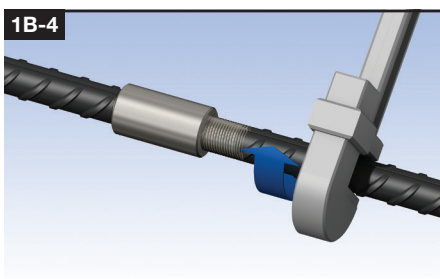

Using a wrench, rotate the continuation bar to lock the two bar ends against each other within the coupler. After tightening, the length of exposed thread should be no more than half of the coupler length plus 2-4mm depending on the diameter of the rebar.



To ensure structural integrity of the connection, any actions, such as on-site bending, which induce cold working of the bar in the threaded region are to be strictly avoided.

1C Installation of BT Type C connection

The Type C contains one BT Coupler, Two Locknuts, one reinforcing bar with a Type C1 thread, and one reinforcing bar with a Type C2 thread.

The bars are typically supplied with the Coupler and Locknuts already installed. In this case, begin with step 1C-3.

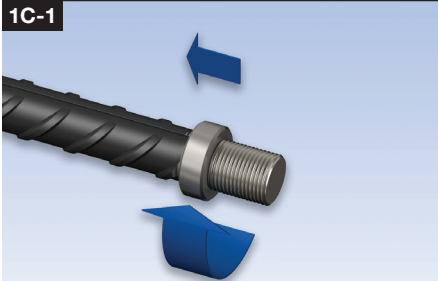

Screw the locknut onto the fixed bar with the Type C1 thread.

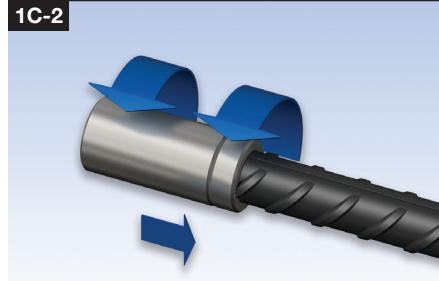

Screw the second locknut followed by the coupler to the end of the thread on the continuation bar with the C2 thread.

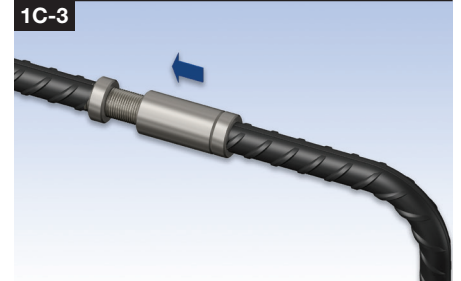

Position the continuation bar with the coupler against the end of the fixed bar.

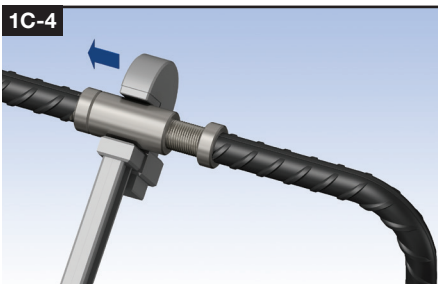

Screw the coupler from the continuation bar onto the fixed bar and lock tight with a wrench against the locknut.

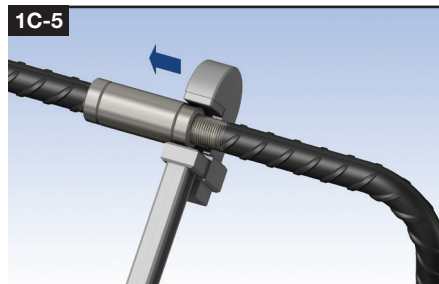

Screw the locknut along the continuation bar to abut the coupler and lock tight with a wrench.



To ensure structural integrity of the connection, any actions, such as on-site bending, which induce cold working of the bar in the threaded region are to be strictly avoided.

2A Installation of BT Type A connection in Two Stage Construction

The Type A connection contains one BT Coupler and two reinforcing bars with Type A threads.

The bars are typically supplied with the Coupler already installed.



Screw the coupler onto the fixed bar and ensure the plastic cap is installed. Place the bar in position with the coupler flush with the formwork and securely tie to the surrounding reinforcement.



Remove the formwork and plastic cap. Position and rotate the continuation bar into the coupler.



Tighten the joint using a wrench on the continuation bar. After tightening there should be no more than 2-4mm of thread exposed, depending on the diameter of the rebar.

2B Installation of BT Type A connection in Two Stage Construction using nailing plate

The Type A connection installed with a nailing plate contains one BT Coupler and two reinforcing bars with Type A threads.

The bars are typically supplied with the Coupler already installed.

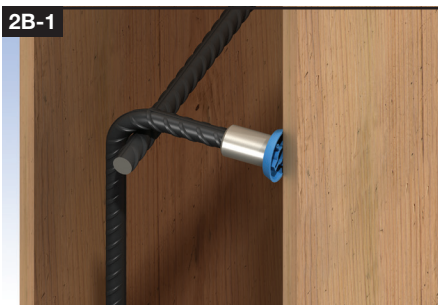

Screw the coupler onto the fixed bar, remove the plastic cap and screw-in the nailing plate. Fix the nailing plate flush with the formwork and tie the bar in position to surrounding reinforcement.



Remove the formwork and nailing plate. Position and rotate the continuation bar into the coupler.



Tighten the joint using a wrench on the continuation bar. After tightening there should be no more than 2-4mm of thread exposed, depending on the diameter of the rebar.



To ensure structural integrity of the connection, any actions, such as on-site bending, which induce cold working of the bar in the threaded region are to be strictly avoided.

3A Installation of BT Type C connection in Two Stage Construction using polystyrene blockout

The Type C connection installed with a polystyrene blockout contains one BT Coupler, two Locknuts, one reinforcing bar with a Type C1 thread, one reinforcing bar with a Type C2 thread and one polystyrene block. The polystyrene block is not supplied by Leviat.

The continuation bar is typically supplied with the Coupler and Locknut already installed. In this case, step 3A-3 is not required.



Place polystyrene foam with minimum dimensions as per table 2 below around the thread of the fixed bar with the C1 thread. Place the bar in position with the thread flush with the formwork and securely tie to the surrounding reinforcement.



Remove the formwork and polystyrene and screw the locknut onto the fixed bar.

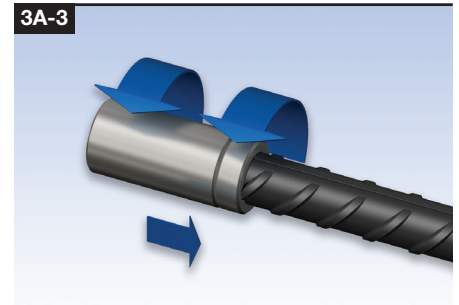

Screw the second locknut followed by the coupler to the end of the thread on the continuation bar with the C2 thread.



Position the continuation bar with the coupler against the end of the fixed bar.



Screw the coupler from the continuation bar onto the fixed bar and lock tight with a wrench against the locknut.



Screw the locknut along the continuation bar to abut the coupler and lock tight with a wrench.

Table 2 - Correlation between bar size and block-out dimensions

Bar Size	Minimum block-out dimension around Type C1 Thread (mm)
N12	40 x 40 x 30
N16	40 x 40 x 40
N20	45 x 45 x 50
N24	55 x 55 x 60
N28	60 x 60 x 65
N32	65 x 65 x 70
N36	80 x 80 x 80
N40	85 x 85 x 85
N50	105 x 105 x 105



To ensure structural integrity of the connection, any actions, such as on-site bending, which induce cold working of the bar in the threaded region are to be strictly avoided.

© Leviat, 2020

The Construction applications and details provided in this guide are indicative only. In every case installation should be entrusted to appropriately qualified and experienced persons. Normal handling precautions should be taken to avoid physical injury. Leviat cannot be held responsible for any injury as a result of using our products, unless such injury arises as a result of our negligence.